



INFRARED ZONE HEATING SYSTEM

OWNER'S MANUAL

Model No. SPP-4PC-1000



WARNING: READ THIS ENTIRE OWNER'S MANUAL CAREFULLY BEFORE USE.

Thank you for choosing a SMART+ PRODUCTS Infrared Zone Heating System. This owner's manual will provide you with valuable information necessary for the proper care and maintenance of your new product. Please take a few moments to thoroughly read the instructions and familiarize yourself with all the operational aspects of your new heater.

PLEASE SAVE THESE INSTRUCTIONS

IMPORTANT SAFETY INSTRUCTIONS

READ AND UNDERSTAND ALL INSTRUCTIONS, SAFETY WARNINGS, AND FAQ'S BEFORE USING THE HEATER



WARNING!



! POTENTIAL FOR ELECTRICAL HAZARD IF NOT ADHERED TO!

When using electrical appliances, basic precautions should always be followed to reduce the risk of fire, electric shock, and injury to persons, including the following:

1. This heater must be plugged into a 120V, 15 amp (or more) circuit of its own. Nothing else can be plugged into the same circuit. If unsure if your home meets this specification, consult a certified electrician prior to use. **Risk of fire, overheat, malfunction, property damage, injury, or even death may result if not adhered to!**
2. Connect to a properly grounded, 3-prong outlet only. Do not connect the heater to extension cords, surge protectors, timers, direct breakers, or an outlet with other appliances connected to the same outlet. **Risk of fire, overheat, malfunction, property damage, injury, or even death may result if not adhered to!**
3. This heater is hot when in use. To avoid burns, do not let bare skin touch hot surfaces. Use handles (certain models) or wheels to move this heater.
4. Keep combustible materials, such as furniture, pillows, bedding, papers, clothes, and curtains at least 3 feet (0.9m) from the front of the heater and keep them away from the sides and rear of the heater.
5. Extreme caution is necessary when any heater is used by or near children, invalids, pets, or when the heater is left operating unattended.
6. Always unplug the heater when not in use.
7. Do not operate any heater with a damaged cord or plug or after the heater malfunctions, has been dropped, or damaged in any manner. Contact the manufacturer for resolution options.
8. Do not use outdoors. Exposure to outdoor elements such as rain, snow, sun, wind or extreme temperatures may cause the heater to become a safety hazard.

9. This heater is not intended for use in bathrooms, laundry areas and similar indoor locations, nor any locations that use GFCI outlets.
10. Never place heater where it may fall into a bathtub or other water receptacles.
11. Do not run cord under carpet. Do not cover cord with throw rugs, runners, or similar coverings. Arrange cord away from traffic area and where it will not be tripped over.
12. The heater must be plugged into a wall outlet that is a DEDICATED CIRCUIT, with a minimum 15 amp rating on that individual circuit.
13. To disconnect the heater: FIRST, turn the power button to the “off” position, then remove plug from the wall outlet.
14. Do not allow foreign objects to enter or block any ventilation or exhaust opening as this may cause an electric shock or fire, or damage the heater.
15. Allow at least 3 feet of unobstructed space to the front and rear of the heater to allow for maximum heat, air, and ventilation flow.
16. A heater has hot and arcing or sparking parts inside. Do not use it in areas where gasoline, paint, or flammable liquids are used or stored, nor use flammable solvents to clean the heater. Also, make sure to keep heater dry at all times.
17. Use this heater only as described in this manual. Any other use not recommended by the manufacturer may cause fire, electric shock, or injury to persons.
18. Do not use abrasive solvents to clean the heater as it may cause damage to the finish or casing.

PLEASE REVIEW FREQUENTLY ASKED QUESTIONS ON THE NEXT FEW PAGES PRIOR TO USING YOUR HEATER.

FREQUENTLY ASKED QUESTIONS (FAQ'S)

My heater emits a “strange” odor when I first open the box/when I turn the heater on for the first time. Why?

These are both normal. This heater is treated with a special heat safe/resistant coating. This odor will sometimes be present when the box is opened, and may be compared to a heaters version of “new car smell.” Also, similar to all hearth appliances (woodstoves, etc.), the coating, exposed to heat, will produce this particular odor during the first few hours of operation. This will dissipate after the break-in period. **If you are sensitive to odors, you may want to pre-burn the unit in a garage with the door open until the initial odor dissipates.**

If my heater runs on approximately 1500 watts, how many BTU's is that? Is that a lot of heat?
At 1500 Watts, your heater will use approximately 5100 BTUs. 5100 BTUs, compared to your home furnace, is a very small amount of heat. It may take several minutes, to several hours to heat your area, depending on various factors (see *Heater Placement*).

Can my heater really operate on less money per day? What are my operating costs?

Yes. If the heater is used as it is intended (as supplement/assist heat), in a well-insulated room, it should cycle on and off, allowing for it to heat in increments. Please note that the costs will increase *if it is used as the single source of heat, in a poorly insulated room, or in an area where heat can escape*, since the “on” cycle will run longer.

The Formula: To determine the cost of this or ANY 1500 watt appliance, multiply 1.5 X your cost per Kilowatt Hour. You can find the cost per KWH for your state at:

<http://www.eia.doe.gov/fuelelectric.html>

What is the life expectancy for the Heating Elements? Can the heating elements be replaced?

The life expectancy of the heating elements is typically 25,000 hours. Heating elements may be replaced by obtaining parts from SMART+ Products, although it is not recommended (unless you are a certified heater technician or authorized directly by SMART+ PRODUCTS). All parts may be purchased through SMART+ PRODUCTS if your product is out of warranty. Note: If you feel that the elements are definitely faulty right out of the box, contact SMART+ PRODUCTS Tech Support first (for troubleshooting). They can then direct you on the next step.

Once I plug the unit in and turn it on, how long will it take to heat my room?

The heating process in the heater begins immediately. A change in the the actual room temperature will vary. Please remember that with any type of heating process, there are many variables: Location of heater (in the home), floor plan and size of the room, how well the room is insulated, how many doors/windows, how much bare concrete (acts as a heat sink with any type of heating), the opening and closing of an exterior door, long hallways, high ceilings, etc. Customers with smaller rooms experience quick heat changes. Others with larger and open floor plans can expect up to 24 hours to heat up.

I don't have a grounded outlet; can I use adapters, a 2-prong power strip, or remove the ground prong from the cord?

Definitely NOT! If you don't have a grounded outlet, contact a certified electrician for advice. Removing or altering any part of the heater's original design or intent (including the power cord) will not only void the warranty, but will make you liable for any unexpected or hazardous results.

Why doesn't the temperature on my heater match the temperature display on my wall, or external thermostat?

This is completely normal. The temperature display on your heater may vary from the temperature display on another thermostat (like the one mounted to your wall or a purchased external thermostat). The temperature sensor on your heater reads the temperature in, and around, the heater. The unit is near the cold floor (and heat rises), which in turn, will display a cooler temperature than elevated or external thermostats. **The best way** to operate your heater is just to set the unit on "High" and dial up to a temperature that feels comfortable to you. Then, leave it at that temperature, regardless of the mismatch. The heater will cycle off when the set temperature is met or exceeded slightly.

My home is not insulated very well, will this heater help me? Can I use the heater if I have vaulted or cathedral ceilings? I live in a structure that is more than 1500 square feet. Will this heater help me? Can I use the heater to heat multiple rooms at the same time? Will I be able to use the heater in a basement or garage?

The answer to these is the same. Yes. You will be able to use it, but keep in mind that rooms/structures with open floor plans, minimal insulation, adjacent rooms, or high ceilings will not retain the heat as efficiently, and may not feel pronounced heat changes. Also, the heater will stay on longer (delays the "off" cycle), and may increase your electric costs. Note that if you do use it in a garage or basement, the moisture levels must be very low and they must have dedicated circuits (15 amps minimum) with no GFCI outlets. If unsure what a GFCI outlet is, contact a certified electrician.

Can I use more than one heater at a time? Can I use the heater and another appliance at the same time?

Yes. But make sure they are not plugged into the same circuit. Each heater (heaters are considered appliances) requires its own minimum 15 amp circuit (**with no other items plugged into that circuit**). If unsure your circuit meets these requirements, verify with a certified electrician. **Risk of fire, damage to property, or injury may result if requirements are not met.**

Why does my heater's fan continue to run even after the set temperature is reached or the power is turned off?

This is normal. The heater's fan will continue to run, even after the heater automatically cycles down. The fan continues to run so that every last bit of heat is blown out of the heat chamber, while allowing the unit to continue filtering your air. Once the internal box/components cool completely, the fan should then shut off on its own. In this case, allow a few minutes after the heat cycles off (with power on). The fan will shut off faster when the power is turned off.

Why doesn't the fan speed increase when I change the setting from LO to HI?

This is normal. The heater's fan's speed is not affected by the HI/LO settings. The fan is designed to vent the heat at one soft, comfortable, and energy efficient speed. What is affected by the HI setting is the heat output. In essence, in the HI mode, the heater produces "more" heat, rather than "faster" heat.

My heater does not perform as well as another brand heater that I purchased. Why Not?

There are many brands of heaters on the market. Each brand is designed with different heat specifications, fan speeds, colors, material types, displays, and electrical components. They are manufactured this way for you, as the consumer to have choices, selection, and preferences. As long as the unit functions as specifications indicate, comparison to other brands will ultimately depend on individual consumer perception.

I purchased my heater so that it could cut my heating costs, but my electric bill has gone up. Why?

The compact SMART+ PRODUCTS heater can definitely save you on heating costs, when compared to the existing central heating system in place in your home, and when used as directed. Your heater is designed to give your main heat source a supplement “boost,” or allow for you to have extra heat (in the form of soft infrared waves) in locations where you would otherwise be short. It is meant to cycle on and off, and not specifically designed to be used as a single heat source, especially in larger homes. If you intend on using it as a single heat source (which you may), expect the heater to 1) take as much as 24 hours to heat the area, 2) stay on for longer periods of time (without cycling off) due to heat loss, and 3) increased use time, and electric costs.

My heater’s display shows my ambient temperature to be in the 20’s, when I know it is warmer than that. Why?

The heater’s display is defaulted to read the temperature as Fahrenheit. If your heater is definitely heating, but shows it is in the 20’s, you probably have the setting to read your temperature in Celsius, rather than Fahrenheit. See Users Guide to change.

My heater has a temperature setting indicating ECO. It is supposed to be efficient, but it seems to not heat as much. Why?

The ECO mode on your heater is a program that attempts to keep the temperature strictly at a “warm” 68° F. This also helps with efficiency, as it is programmed to 1) Increase the wattage used to 1500W if the temperature drops below 64.4°F 2) Gradually reduce the wattage used as it approaches 66.2° F and 3) Stop heating when 68° F is achieved. This is considered an Economical function, since in the ECO setting, the heater is almost never running on the full 1500 Watts. If this “warm” heat is not plentiful or is on constantly, and you fear it will increase your electric bills, we recommend you set it to the high or low setting and have it cycle off when your set temperature is achieved. You may also set the timer to allow your heater to shut off at the set hour increments you desire.

SPECIFICATIONS

Voltage Rating	120 V (60Hz)
Power Consumption	1500W
Unit Size	13.1 in. (W) x 16.6 in. (D) x 16.9 in. (H)
Unit Weight	19 lbs

SAFETY FEATURES

Tip-Over Safety Feature

This heater is equipped with a tip-over safety feature. Once the heater is tipped over, an internal switch will automatically shut the heater off. Once the heater is restored an upright position, the heater will reset. To continue operation, turn on the heater using the supplied remote control or the control panel on the heater.

Overheat Safety Feature

This heater is equipped with a overheat safety feature. When the heaters internal components reach a certain temperature that could cause overheat and possible fire, the heater will automatically shut off.

WARNING: It is normal for the power cord to feel warm to the touch; however, a loose fit between the outlet and the plug may cause overheating of the plug. If this occurs, try inserting the plug into a different outlet. Contact a qualified electrician to inspect the original outlet for damage.

IN THE BOX

- INFRARED ZONE HEATING SYSTEM
- REMOTE CONTROL (2 AAA batteries not Included)
- INSTRUCTION BOOKLET

PRODUCT DIAGRAM

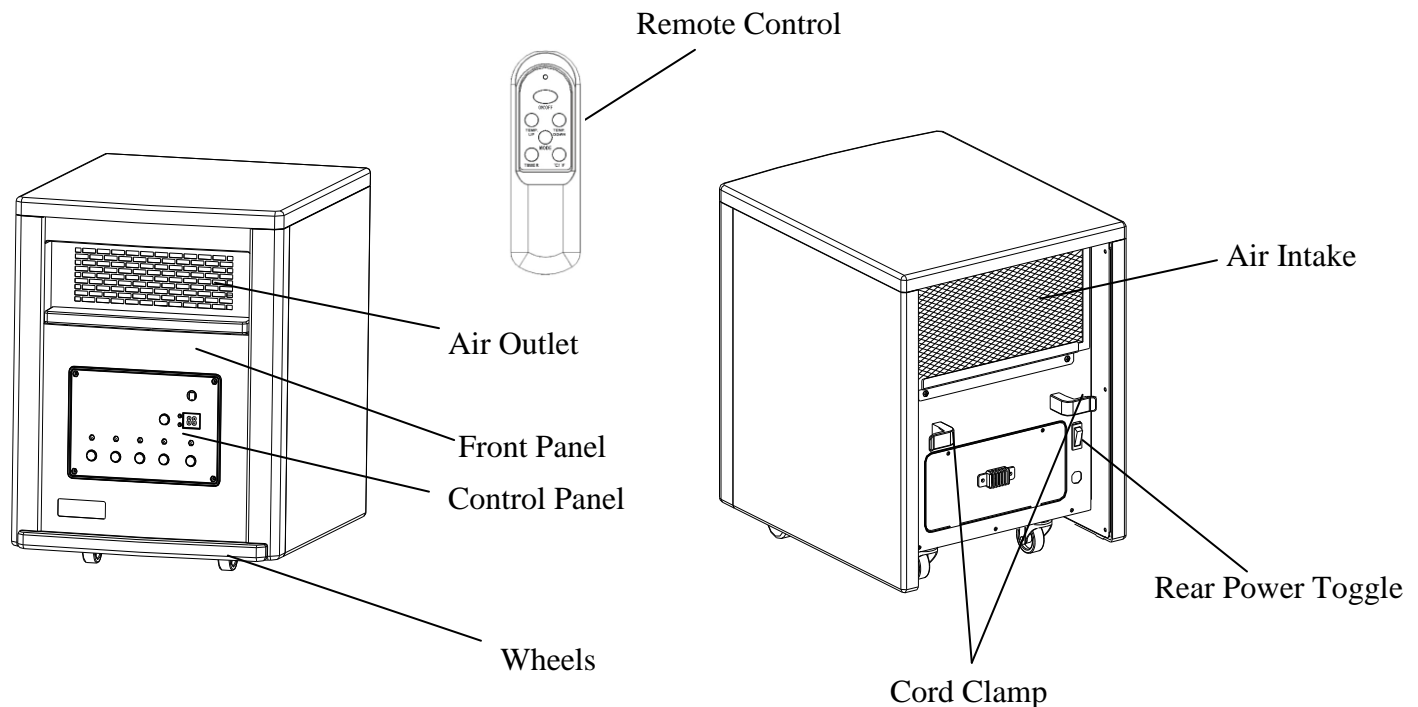

Control Panel (Ref Fig. 1 next page)

1. Remote control signal sensor
2. Digital display: Indicates set desired room temperature
3. Power indicator light: Indicates that the heater is receiving power from outlet. Will flash when powered "ON"
4. ON/OFF button: Powers the display on and off
5. Energy-saving mode indicator: Will be lit when energy-saving mode is engaged
6. Mode button: To select between High, Low, and Eco modes
7. Low Mode indicator light: Will be lit when Low Heat mode is engaged
8. Temp up button: To increase desired temperature
9. High Mode indicator light: Will be lit when High Heat mode is engaged
10. Temp down button: To decrease desired temperature
11. Timer indicator light: Will be lit when the Timer mode is engaged
12. Timer button: Used to engage timer mode and to set hour value for the timer
13. Fahrenheit indicator light: Will be lit when temperature displayed is in Fahrenheit
14. °C/°F Button: Alternates the display readings between Fahrenheit and Celsius
15. Celsius indicator light: Will be lit when temperature displayed is in Celsius

Fig. 1

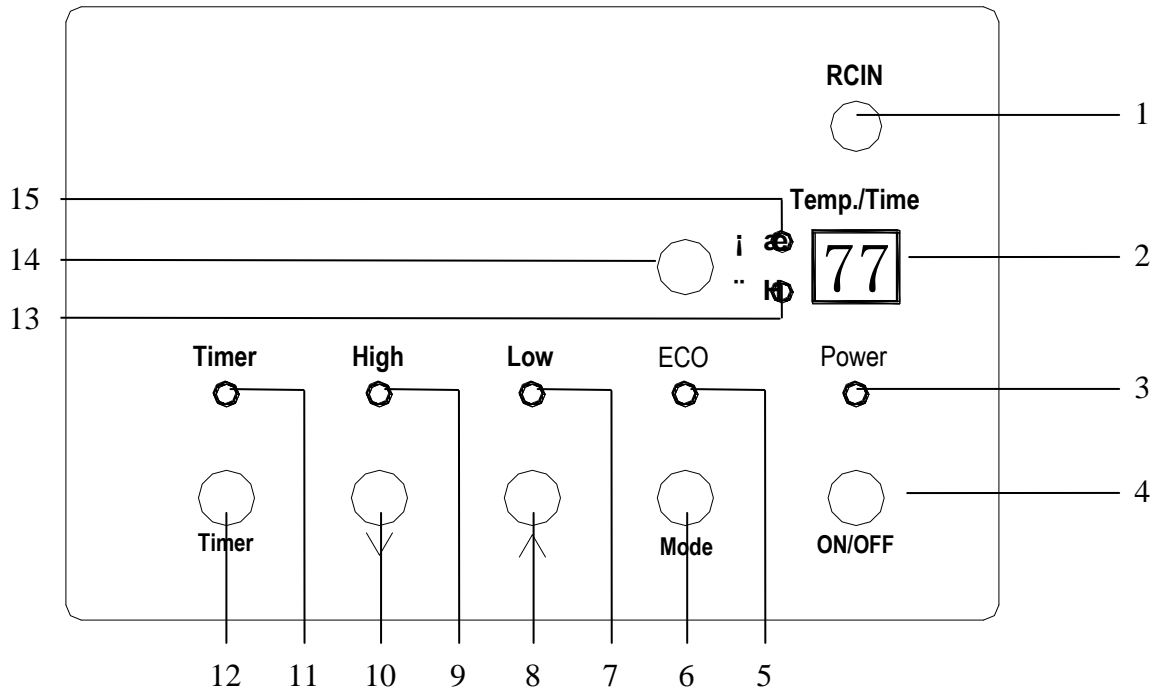

Remote Control

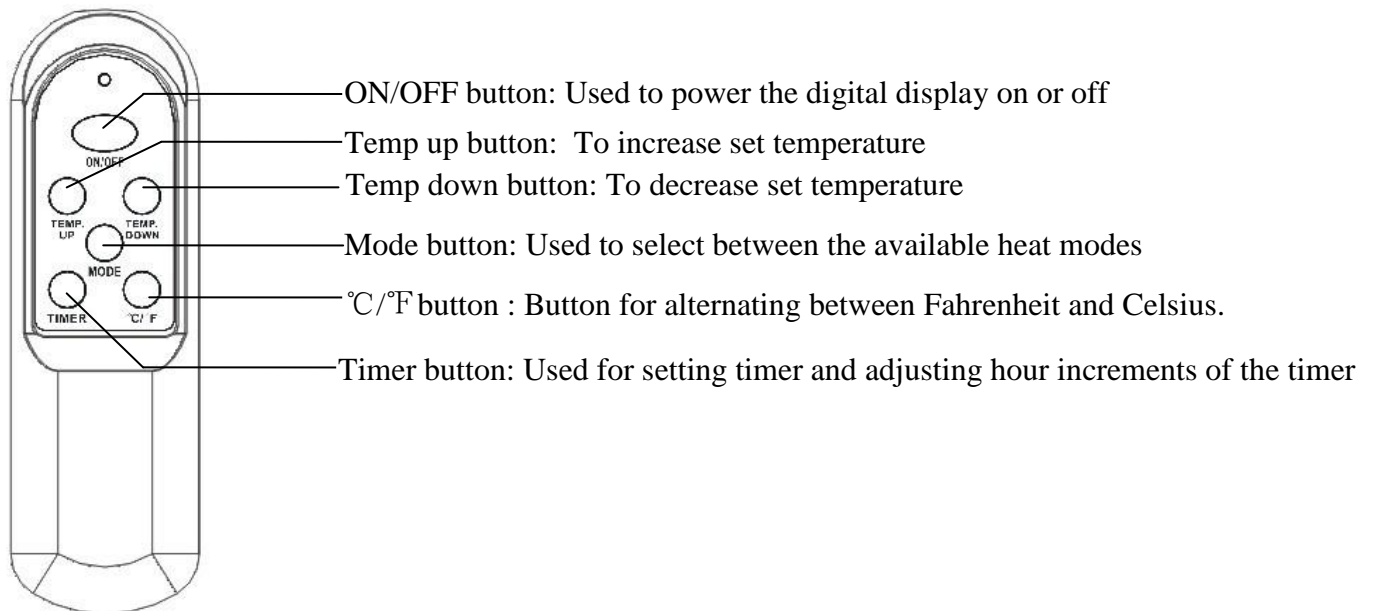

PREPARATION

Place the heater on a firm, level surface and plug into a grounded 120V 60Hz power outlet, and turn on the power switch in the rear of the unit.

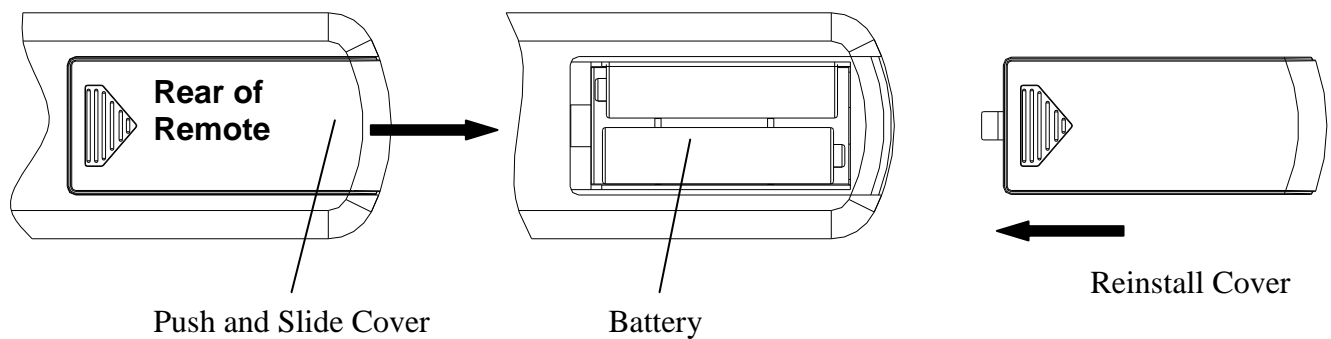

Only operate heater in upright position with caster wheels attached.

Insert 2 AAA batteries into the remote control before using (**Batteries Sold Separately**).

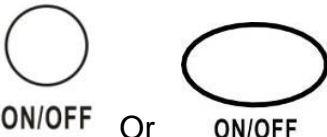
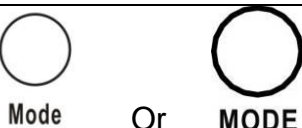

OPERATING INSTRUCTIONS

1. Power the Display On/Off and Select Desired Mode

	<p>Turn the heater on by pressing the ON/OFF button on the control panel or by pressing the Power button on the supplied remote control.</p> <p>Turn the heater off by pressing the ON/OFF button on the control panel or by pressing the Power button on the supplied remote control.</p> <p>Note: Powering off the heater will stop the heating process only. The fan will continue to blow for approximately 1 more minute to allow for the interior components to cool. The fan will then turn off automatically.</p>
	<p>Select a heat Mode.</p> <p>Press the MODE button to toggle between the three heat modes.</p>
	<p>High Mode uses 1500W; Low Mode uses 750W. ECO mode is an Economic Energy Saving Function. When ECO mode is chosen, the heater will manage itself from less to more heating power (watts) in an attempt to maintain a constant warm 68°F (20°C).</p>

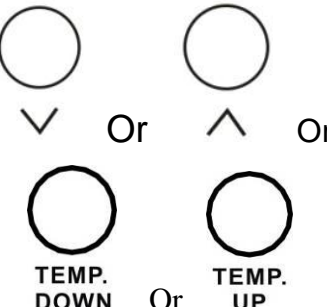
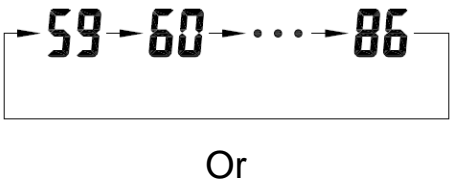

2. Setting Desired Temperature

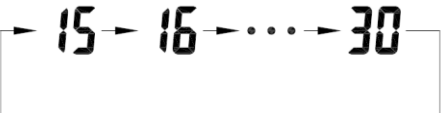
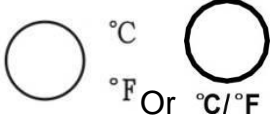
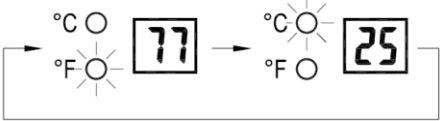
	<p>Adjust the desired temperature by pressing the Up/Down arrows on the control panel or remote control.</p>
	<p>Desired temperature options vary from 59°F to 86°F, or from 15°C to 30°C. Once you have chosen the desired temperature, the heater will remain on until the room temperature increases to the temperature on the digital display. The heater will cycle on and off to maintain that desired room temperature.</p>

	
	<p>Press °C/°F button to change the display temperature between Fahrenheit and Celsius.</p>
	<p>The Fahrenheit indicator LED will light, when the temperature is displayed in Fahrenheit. The Celsius LED will light, when the temperature is displayed in Celsius.</p>

3. Setting the POWER OFF TIMER Function

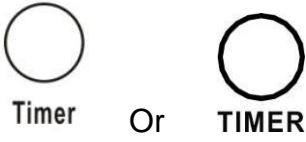
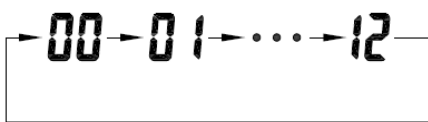
Note: The Power-Off-Timer Function will allow for the heater to power OFF after a certain set time, and can only be set while the heater’s display is in the “On” position.

	<p>Turn the heater to the “On” position. Press the Timer button on the heater’s control panel or the remote.</p>
	<p>The digital display changes from the “temperature” to the “hours” option for the timer. Continue to press the timer button to change the number of hours you would like the heater to run before powering itself off. The hour options for the timer are from 0 to 12 hrs. (in 1 hr increments).</p>
	<p>The selected hour increments will flash for a few seconds, then revert back to the set desired temperature. The Timer indicator light will remain lit as long as the Timer is set. The heater will power OFF when the internal heater clock counts down the hour increments you set.</p>

4. Setting the POWER-ON-TIMER Function

Note: The Power-ON-Timer Function will allow for the heater to power ON after a certain set time, and can only be set while the heater’s display is in the “Off” position.

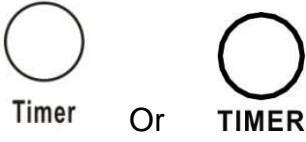
	<p>Turn the heater to the “OFF” position. Press the Timer button on the heater’s control panel or the remote.</p>
---	---

	<p>The digital display shows the “hours” option for the timer. Continue to press the timer button to change the number of hours you would like the heater’s internal clock to count down before powering itself on. The hour options for the timer are from 0 to 12 hrs (in 1 hr increments).</p>
<p>Timer</p>	<p>The Timer indicator light will remain lit as long as the Timer is set. The heater will power itself ON when the internal heater clock counts down the hour increments you set.</p>

5. Setting Electro Lock

The Electro Lock can help avoid the heater from being accidentally engaged by children. The locking mechanism can be set in both the ON and OFF modes.

	<p>Press Temp Up and Temp Down buttons at the same time for 3 seconds. Locking is complete when you hear a beep. When locked, the functions of the control panel and remote will be locked for use.</p>
	<p>When you need to unlock it, press Temp Up and Temp Down buttons at the same time for 3 seconds. You will hear a beep. The control panel and remote control will become functional again.</p>

MAINTENANCE

1. Unplug the unit and let it cool completely.
2. To keep the heater clean, the outer shell may be cleaned with a soft, damp cloth. You may use a mild detergent if necessary. After cleaning, dry the unit with a soft cloth. **CAUTION: DO NOT** let liquid enter the heater.
3. **DO NOT** use alcohol, gasoline, abrasive powders, furniture polish, or rough brushes to clean the heater. This may cause damage or deterioration to the surface of the heater.
4. **DO NOT** immerse the heater in water.
5. Wait until the unit is completely dry before use.
6. Air filter needs cleaning after 3 months of use. Please take off the filter with the 3 steps in the drawing below. Flush and clean the filter with water. Then, dry it out and re-assemble.

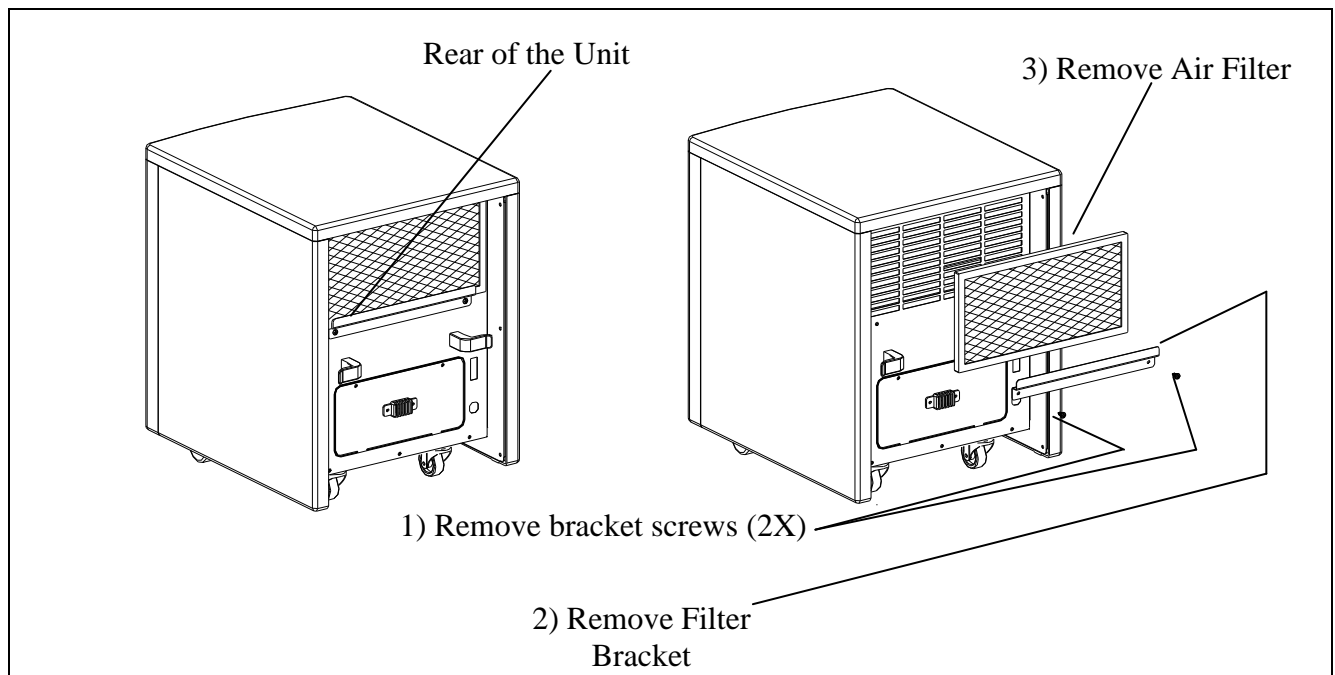

7. If you do not use the heater for a long time, please take out the remote batteries (to prevent corrosion) as shown below. Store the remote in a safe place.

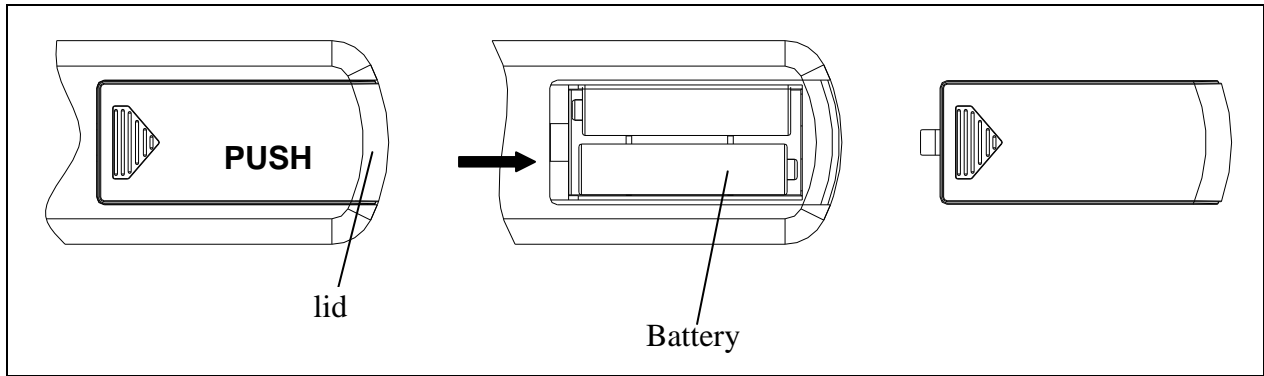

STORAGE

Store the heater in a cool, dry location when not in use. To prevent dust and dirt build-up, use the original packaging to repack the unit.

BASIC TROUBLESHOOTING

If the heater will not operate, please check the following before seeking repair advice:

1. Check if the power cord is plugged into an electrical outlet, if not, plug in.
2. Check if power to the main power switch (in the back) is working.
3. Check to see if the battery on the remote is placed correctly, undamaged, and if the insulating film is pulled out.

NOTE: For the heater to function properly, the desired temperature on the heater must be set a few degrees higher than the temperature in the room. If it seems to not be heating, increase the desired temperature on the heater to engage the heat elements.